

REVISIONS

REV#	DESCRIPTION	APPV.	REV DATE

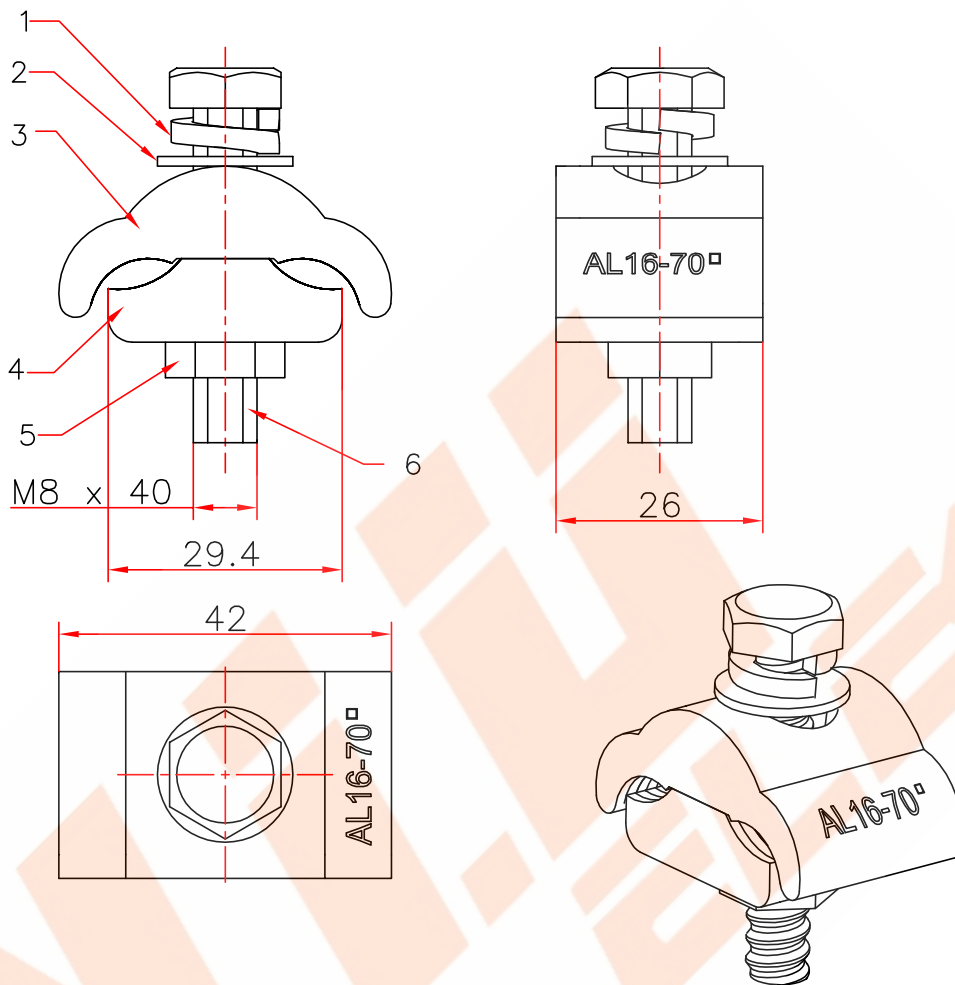

AL wire cross section : 16–70 mm<sup>2</sup>

6	BOLT	MILD STEEL		1
5	NUT	MILD STEEL		1
4	BOTTOM BODY	ALUMINIUM ALLOY	NATURAL & BRIGHT	1
3	TOP BODY	ALUMINIUM ALLOY	NATURAL & BRIGHT	1
2	WASHER	ALUMINIUM ALLOY	NATURAL & BRIGHT	1
1	ROUDE SPRING WASHER	MILD STEEL		1
SR. NO	ITEM DESCRIPTION	MATERIAL	FINISH	QTY



N.I.U ELECTRIC GROUP CO.,LTD  
 Beibaixiang Zone, Yueqing City,  
 Zhejiang Province, China-325604  
 Tel: +86-577-62622652  
 E-mail: sales@niuelec.com

DRAWN: David

DRG No: NIU#  
 APG-A AL16-70

CHECKED: